

SunPower® X-Series Residential Solar Panels | X22-360

More than 22% Efficiency

Ideal for roofs where space is at a premium or where future expansion might be needed.

Maximum Performance

Designed to deliver the most energy in demanding real-world conditions, in partial shade and hot rooftop temperatures.^{1,2,4}

Premier Technology

Engineered with the newest and most powerful Maxeon technology, X-Series brings unmatched power and performance to your home.

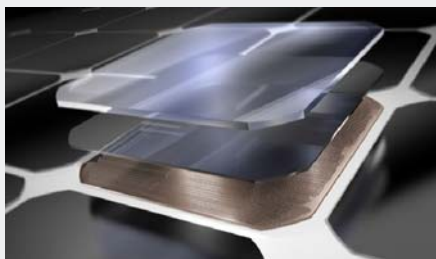

Maxeon™ Solar Cells: Fundamentally better

Engineered for performance, designed for durability.

Engineered for Peace of Mind

Designed to deliver consistent, trouble-free energy over a very long lifetime.^{3,4}

Designed for Durability

The SunPower Maxeon Solar Cell is the only cell built on a solid copper foundation. Virtually impervious to the corrosion and cracking that degrade conventional panels.³

Same excellent durability as E-Series panels.

#1 Rank in Fraunhofer durability test.⁹

100% power maintained in Atlas 25+ comprehensive durability test.¹⁰

High Performance & Excellent Durability

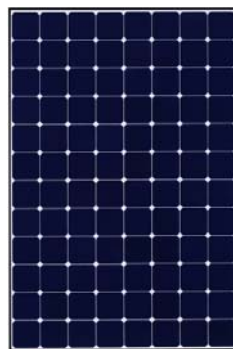

SPR-X22-360



Highest Efficiency⁵

Generate more energy per square meter

X-Series residential panels convert more sunlight to electricity by producing 38% more power per panel¹ and 70% more energy per square meter over 25 years.^{1,2,3}

Highest Energy Production⁶

Produce more energy per rated watt

High year-one performance delivers 8–10% more energy per rated watt.² This advantage increases over time, producing 21% more energy over the first 25 years to meet your needs.³

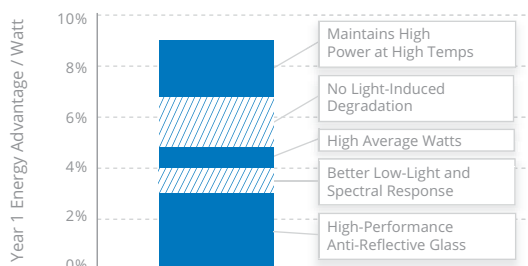
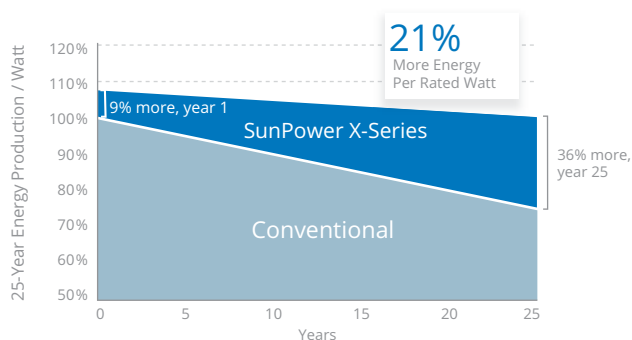

SunPower® X-Series Residential Solar Panels | X22-360

SunPower Offers The Best Combined Power And Product Warranty

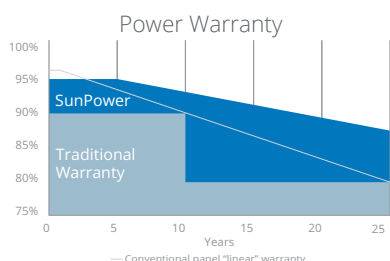

More guaranteed power: 95% for first 5 years, -0.4%/yr. to year 25⁷

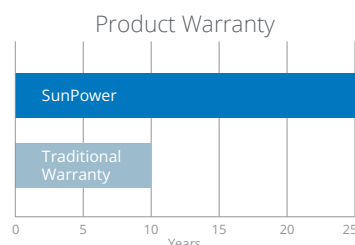

Combined Power and Product defect 25-year coverage⁸

Electrical Data

	SPR-X22-360
Nominal Power (P _{nom}) ¹¹	360 W
Power Tolerance	+5/-0%
Avg. Panel Efficiency ¹²	22.2%
Rated Voltage (V _{mpp})	59.1 V
Rated Current (I _{mpp})	6.09 A
Open-Circuit Voltage (V _{oc})	69.5 V
Short-Circuit Current (I _{sc})	6.48 A
Max. System Voltage	1000 V IEC & 600 V UL
Maximum Series Fuse	15 A
Power Temp Coef.	-0.29% / °C
Voltage Temp Coef.	-167.4 mV / °C
Current Temp Coef.	2.9 mA / °C

Tests And Certifications

Standard Tests ¹³	IEC 61215, IEC 61730, UL1703 (Type 2 Fire Rating)
Quality Certs	ISO 9001:2008, ISO 14001:2004
EHS Compliance	RoHS, OHSAS 18001:2007, lead free, PV Cycle, REACH SVHC-163
Sustainability	Cradle to Cradle Certified™ Silver
Ammonia Test	IEC 62716
Desert Test	10.1109/PVSC.2013.6744437
Salt Spray Test	IEC 61701 (maximum severity)
PID Test	Potential-Induced Degradation free: 1000 V ⁹
Available Listings	TUV, UL, JET, CEC

Operating Condition And Mechanical Data

Temperature	-40° C to +85° C
Impact Resistance	25 mm diameter hail at 23 m/s
Appearance	Class A+
Solar Cells	96 Monocrystalline Maxeon Gen III
Tempered Glass	High-transmission tempered anti-reflective
Junction Box	IP-65 Rated, MC4
Weight	18.6 kg
Max. Load	G5 Frame: Wind: 3000 Pa, 305 kg/m ² Snow: 6000 Pa, 611 kg/m ² G3 Frame: Cyclonic Wind: 7500 Pa, 764 kg/m ² ¹⁴ Snow: 5400 Pa, 550 kg/m ²
Frame	Class 1 black anodised (highest AAMA rating)

REFERENCES:

- All comparisons are SPR-X21-345 vs. a representative conventional panel: 250 W, approx. 1.6 m², 15.3% efficiency.
- Typically 8-10% more energy per watt, BEW/DNV Engineering "SunPower Yield Report," Jan 2013.
- SunPower 0.25%/yr degradation vs. 1.0%/yr conv. panel. Campeau, Z. et al. "SunPower Module Degradation Rate," SunPower white paper, Feb 2013; Jordan, Dirk "SunPower Test Report," NREL, Q1-2015.
- "SunPower Module 40-Year Useful Life" SunPower white paper, May 2015. Useful life is 99 out of 100 panels operating at more than 70% of rated power.
- Highest of over 3,200 silicon solar panels, Photon Module Survey, Feb 2014.
- 1% more energy than E-Series panels, 8% more energy than the average of the top 10 panel companies tested in 2012 (151 panels, 102 companies), Photon International, Feb 2013.
- Compared with the top 15 manufacturers. SunPower Warranty Review, May 2015.
- Some restrictions and exclusions may apply. See warranty for details.
- X-Series same as E-Series, 5 of top 8 panel manufacturers tested in 2013 report, 3 additional panels in 2014. Ferrara, C., et al. "Fraunhofer PV Durability Initiative for Solar Modules: Part 2". Photovoltaics International, 2014.
- Compared with the non-stress-tested control panel. X-Series same as E-Series, tested in Atlas 25+ Durability test report, Feb 2013.
- Standard Test Conditions (1000 W/m² irradiance, AM 1.5, 25° C). NREL calibration Standard: SOMS current, LACCS FF and Voltage.
- Based on average of measured power values during production.
- Type 2 fire rating per UL1703:2013, Class C fire rating per UL1703:2002.
- AS/NZS4040.2 Static strength test regime, AS/NZS1170.2 Structural Design Actions - Wind Actions.

AUSTRALIA WIDE
SOLAR

02 9533 7444

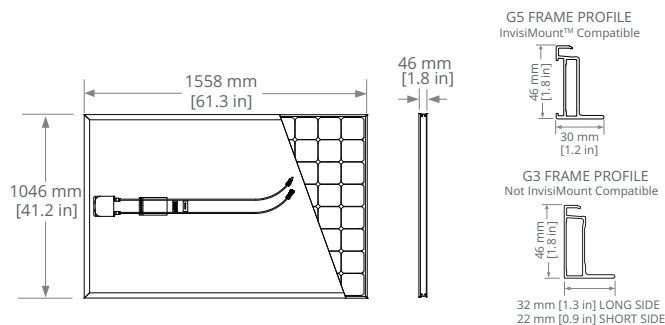

Please read the safety and installation guide.

See www.sunpower.com/facts for more reference information.
For more details, see extended datasheet: www.sunpower.com.au/datasheets.

Document # 518557 Rev B /A4_UK_AUS